

RAZER650i

PROFILE

USER MANUAL

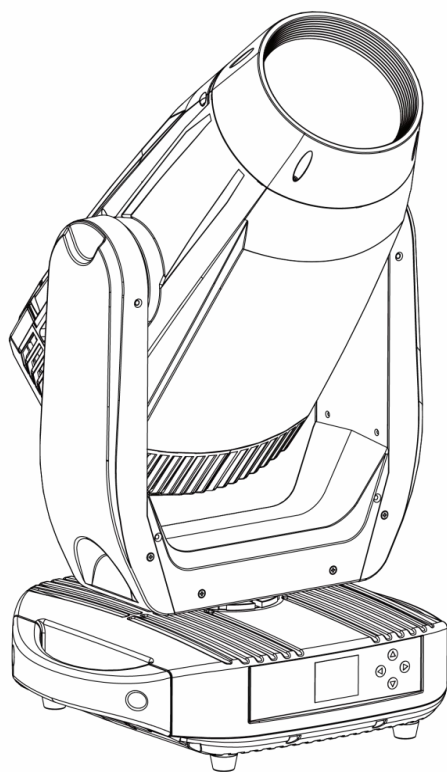

1 PRODUCT

1.1 TECHNICAL SPECIFICATIONS

LED colors	1 LED(CW) 650W
Angle	5-50°
Power	800W
Control Protocol	DMX512, RDM, Artnet, sACN, W-DMX(Optional)
Voltage Range	AC100~240V,50/60Hz
Input Current	110V/7.3A,220V/3.7A
Protection	IP66
Operation Temperature	-20°C~45°C
Dimensions	416X364X728mm
Weight	35kg

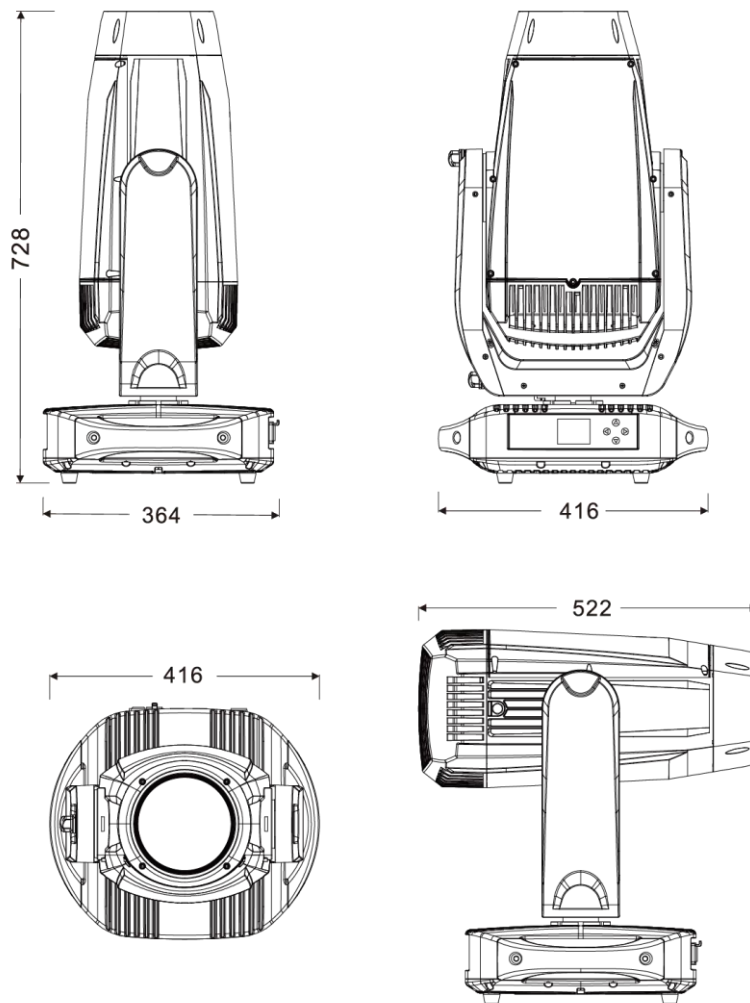

1.2 Safety Notes

IMPORTANT

- This product must be installed by a qualified professional.
- In order to maintain this condition and to ensure a safe operation, it is absolutely necessary for the user to follow the safety instructions and warning notes
- The manufacturer will not accept liability for any resulting damages caused by the non-observance of this manual or any unauthorized modification to the device.

CAUTION!

- Make sure that the available voltage is not higher than stated on the rear panel.
- Do not touch the power cables if your hands are wet.
- The earth wire must always be connected to the ground. Therefore it is essential to connect the yellow/green conductor to earth.
- Make sure that the power-cord is never crimped or damaged by sharp edges. Check the device and the power-cord from time to time. The electric connection, repairs and servicing must be carried out by a qualified employee.
- Always disconnect power input cable to completely remove power from unit when not in use or before cleaning or servicing the fixture.
- Do not switch the fixture on and off in short intervals as this would reduce the lamp's life.
- Do not touch the device's housing bare hands during its operation (housing becomes hot)! The surface of the product's casing can reach up to 70° C (158° F) during operation. Avoid contact by persons and materials. Do not install the product in a location where there is a risk of accidental contact. Allow the product to cool for at least 10 minutes before handling.
- For replacement use lamps and fuses of same type and rating only.
- Please protect the fixture and avoid destroy during transport and installation. If there is any damage to the coating, the shell may be corroded.
- When hanging lamps and lanterns, it is necessary to verify that facilities and hooks can bear at least 10 times the weight of lamps and lanterns.
- Fix the safety rope at the correct holes only. Only operate the fixture after having checked that the housing is firmly closed and all screws are tightly fastened.
- The maximum ambient temperature 45°C must never be exceeded. Do not operate the product if the ambient temperature (Ta) exceeds 45° C (115° F).
- During the initial start-up some smoke or smell may arise. This is a normal process and does not necessarily mean that the device is defective.

Electrical Warning

- The light source contained in this luminaire shall only be replaced by the manufacturer or his service agent or a similar qualified person
- For replacement use lamps and fuses of same type and rating only.
- The lens has to be replaced when it is obviously damaged, so that its function is impaired, e. g. due to cracks or deep scratches!

Keep the product well away from flammable materials

- Keep all combustible materials (e.g. fabric, wood, paper) at least 500 mm (20 in.) away from the product.
- Ensure that there is free and unobstructed airflow around the product. Provide a minimum

clearance of 150 mm (6 in.) around fans and air vents.

- Do not illuminate surfaces within 3 m (10 ft.) of the product.
- Do not install a fuse that has a higher rating than the one originally installed in the product. Do not bypass fuses.
- Do not stick filters, masks or other materials onto optical components.
- If the fixture seems to be abnormally hot, shows signs of melting or emits smoke, disconnect the fixture from power immediately and allow it to cool. Do not touch the fixture without heatproof safety gloves. Keep the fixture well away from combustible and flammable materials.

**NEVER LOOK DIRECTLY INTO THE LIGHT SOURCE!
RETINA INJURY RISK - MAY INDUCE BLINDNESS!**

Do not point the front of the fixture towards the sun or other strong light sources. The front lens focuses and concentrates light just like a magnifying glass. Strong light can cause internal damage to the fixture, melting components or starting an internal fire within seconds.

To avoid problems from strong light sources:

- Do not expose the front of a fixture to sunlight or any other strong light source. Avoid pointing other high-powered beam lights directly at the fixture.
- Do not focus a light beam from one lighting fixture directly towards another.
- For outdoor applications during daylight, make sure that the front face of any fixture is shielded or points away from the sun, even when not in use.
- Do not expose the product to heat (from other lighting fixtures for example).

2 INSTALLATION

2.1 MOUNTING

Truss installation

- ◆ Keep all combustible materials (e.g. fabric, wood, paper) at least 500 mm (20 in.) away from the product.
- ◆ For overhead use, always install a safety cable that can hold at least 10 times the weight of the fixture.
- ◆ For overhead installation, the fixture must be always secured with a safety wire that can bear at least 10 times the weight of the fixture;
- ◆ Secure the fixture with a safety cable through the rear safety eye and truss as shown..
- ◆ Ensure that the structure (truss) to which you are attaching the fixture is secure

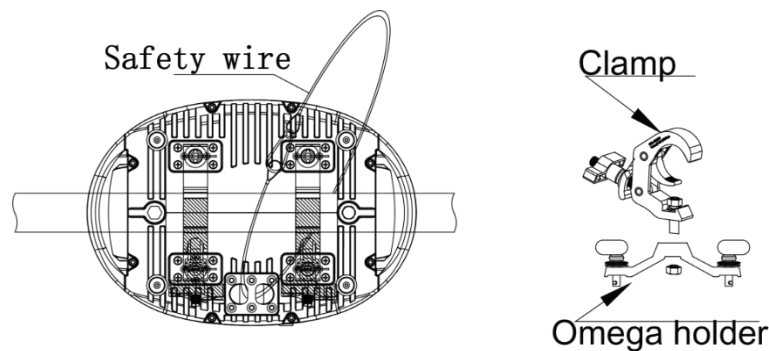

FIXTURE MOUNTING POSITION

- ◆ The fixture may be mounted in any position in which the base of the fixture is oriented horizontally.
- ◆ Acceptable positions include standing the fixture upright or hanging the fixture upside-down.
- ◆ Do NOT install the fixture in a sideways position, or in any position in which the base of the fixture is oriented vertically or at an angle.

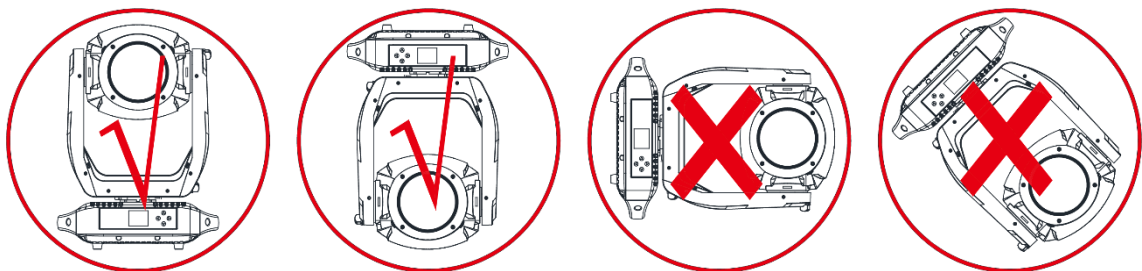

2.2 Fuse replacement

- ◆ Remove the safety cap by a screwdriver.
- ◆ Fetch the old fuse from safety cap.
- ◆ Install a new fuse.
- ◆ Install the safety cap.

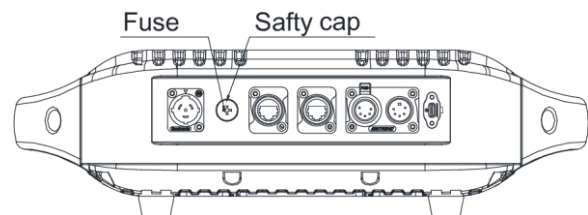

2.3 POWER CONNECTIONS

- ◆ This product has an auto-ranging power supply that can work with an input voltage range of 100–240 VAC, 50/60 Hz.

AC Plug

Connection	Wire (U.S.)	Wire(Europe)	Screw Color
AC Live	Black	Brown	Yellow/Brass
AC Neutral	White	Blue	Silver
AC Ground	Green/Yellow	Green/Yellow	Green

2.4 Data network requirements

- ◆ Connect the DMX512 controller to the units in series. A DMX 512 data link is required in order to control the fixture via DMX. The fixture has 3/5-pin XLR connectors for DMX data input and output.
- ◆ Each unit has N DMX channels so the DMX Addresses should increase by increments of 1, (Nx1)+1, (Nx2)+1, (Nx3)+1...
- ◆ Any DMX address in the range from 001 to 512 may be used.
- ◆ Connect the DMX-output of the first fixture in the DMX chain with the DMX-input of the next fixture. Always connect one output with the input of the next fixture until all fixtures are connected.
- ◆ Caution: At the last fixture, the DMX-cable has to be terminated with a terminator. Solder a 120 Ω resistor between Signal (-) and Signal (+) into a 3/5-pin XLR-plug and plug it in the DMX-output of the last fixture.

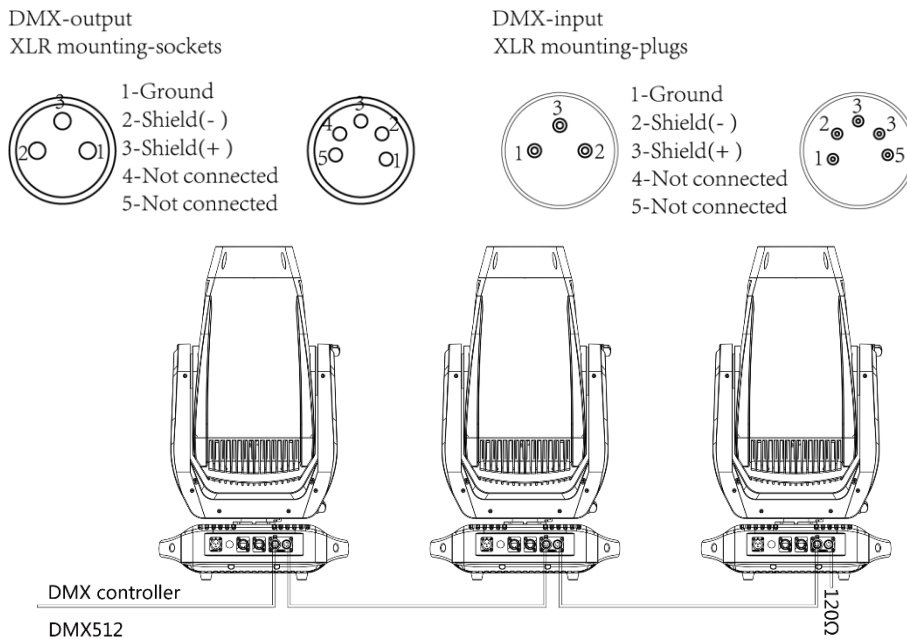

2.5 Update software

- ◆ Steps of updating software with USB-C interface:
 1. Insert USB-C U dish into USB-C interface
 2. After finding "Upgrade Software" in the menu, Find the corresponding software and click OK

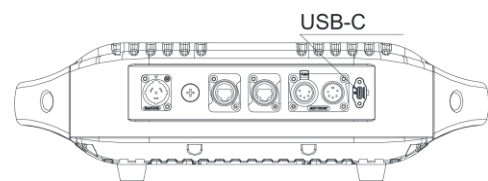

3 FUNCTIONS AND SETTINGS

3.1 DISPLAY OPERATION

- ◆ MENU: Used to access the menu or to return a previous menu option;
- ◆ ENTER: Used to select and store the current menu or confirm the current function value or option within a menu;
- ◆ UP: Navigates downwards through the menu list and increases the numeric value when in a function;
- ◆ DOWN: Navigates upwards through the menu list and decreases the numeric value when in a function;
- ◆ Lock screen password: Long press 5s Left, Input after the screen is bright - UP/DOWN/UP/DOWN

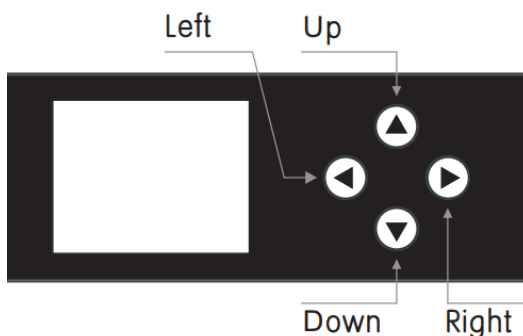

3.2 Menu Map

ADDRESS	001 – 512(Default 001)		DMX address setting
PERSON	BASIC		Use the menu to select desired channel mode
	STANDARD (Default)		
	EXTEND		
RUNMODE	DMX512 (Default)		Select Signal
	ARTNET		Default: DMX512
	ARTNET TO DMX		CUSTOM1-2 Set up get into EDIT MENU
	sACN		edit
	AUTO		
	CUSTOM1		
	CUSTOM2		
OPTION	PAN INVERT	OFF (Default)	PAN moving direction selection
		ON	
	TILT INVERT	OFF (Default)	TILT moving direction selection
		ON	
	PERFORM	STUDIO	Fan mode low speed
		POWER	Fast rotation of fan, all power
		LIVE (Default)	Automatic rotation of fan
	BLACKOUT	OFF (Default)	Select OFF blackout without delay
		ON	Select ON Blackout delay 3s
	DIMMER	DIM4 (Default)	Dimming curves DIM1 (fast) to DIM4 (slow);
		DIM3	
		DIM2	

		DIM1			
		OFF			
	LED PWM	1200Hz (Default)		Sets the PWM frequency	
		2400Hz			
		4000Hz			
		6000Hz			
		25000Hz			
	DMX ERROR	SAVE (Default)		Hold after loss of DMX signal	
		BLACK		Blackout after loss of DMX signal	
	DISPLAY TIME	On		Display backlight always on	
		30s		Turns off display backlight after 30s/1min /2min of inactivity	
		1min (Default)			
		2min			
	DISPLAY LOCK	OFF		Locks display (passcode is <UP>, <DOWN>,<UP>, <DOWN>, <ENTER>)	
		ON (Default)			
	LOAD PARA	YES		Upload data	
		NO		Not upload data	
	SETTING	RECOVERY	****		Restore default factory settings.
		CLEAN EDIT1	****		Clean customer self-editing scene 1
		CLEAN EDIT2	****		Clean customer self-editing scene 2
		WDMX HIDE	YES	Hide wireless mode WDMX reset and signal hide and the default is wired mode only	
		NO			
	NETWORK	Net SWITCH	OFF		Net switch off IP mode
			ON		Net switch on IP mode
		UNIVERS	0-255		Packet group Settings
		IP MODE	DEFAULT IP		Default IP
			CUSTOM IP		Customer's IP
	CUSTOM IP	XX.XX.XX.XX		Customer's IP setting	
	PT ENCODER	OFF		XY Encoder switch.	
		ON		OFF is close; ON is open.	
	LANGUAGE	****	Chinese		Language setting
			English(Default)		
	WDMX RESET	NO		Do not clear the receiver's message.	
		YES		Clear the receiver's message	
	SIGNAL	ONLY XLRDMX		ONLY XLR is wire only	
		XLRDMX FIRST		XLR FIRST is wire first	
		ONLY WDMX		ONLY WDMX is wireless only	
		WDMX FIRST		WDMX FIRS is wireless first	
		WDMX TO XLRDMX		WDMX TO DMX is wireless to wired	
EDIT	EDIT 1-2	STEP 1-30	PAN	0-255	Edit the custom programs1-30 Select play 【EDIT 1】 in RUNMOEDE CUSTOM 1; Select play 【EDIT 2】 in RUNMOEDE CUSTOM 2
			TILT	0-255	
			PT SPEED	0-255	
			CMY C	0-255	
			CMY M	0-255	
			CMY Y	0-255	

			CTO	0-255	
			COLOR	0-255	
			FIXED GOBO	0-255	
			ROTA.GOBO	0-255	
			GOBO.ROTA	0-255	
			ANIMATION.D	0-255	
			ANIMATION.R	0-255	
			PRISM	0-255	
			FROST 1	0-255	
			FROST 2	0-255	
			ZOOM	0-255	
			FOCUS	0-255	
			IRIS	0-255	
			FRAMING1.L	0-255	
			FRAMING1.R	0-255	
			FRAMING2.L	0-255	
			FRAMING2.R	0-255	
			FRAMING3.L	0-255	
			FRAMING3.R	0-255	
			FRAMING4.L	0-255	
			FRAMING4.R	0-255	
			FRAMING ROT	0-255	
			DIMMER	0-255	
			STROBE	0-255	
			TIME	0-255	
			USE	YES/NO	Select YES to run the steps user need.
MANUAL	Auto Test				Auto Test channel
	CHANNEL	PAN	0-255		Manual control channel
		TILT	0-255		
		PT SPEED	0-255		
		CMY C	0-255		
		CMY M	0-255		
		CMY Y	0-255		
		CTO	0-255		
		COLOR	0-255		
		FIXED GOBO	0-255		
		ROTA.GOBO	0-255		
		GOBO.ROTA	0-255		
		ANIMATION.D	0-255		
		ANIMATION.R	0-255		
		PRISM	0-255		
		FROST 1	0-255		
		FROST 2	0-255		
		ZOOM	0-255		
	FOCUS	0-255			
	IRIS	0-255			

		FRAMING1.L	0-255	
		FRAMING1.R	0-255	
		FRAMING2.L	0-255	
		FRAMING2.R	0-255	
		FRAMING3.L	0-255	
		FRAMING3.R	0-255	
		FRAMING4.L	0-255	
		FRAMING4.R	0-255	
		FRAMING ROT	0-255	
		DIMMER	0-255	
		STROBE	0-255	
	DEBUG HIDE	NO		Factory testing mode. All stepper motors are not controlled by signal, It only works again after the reset.
		YES		
RESET	ALL RESET		Select Yes/No to carry out all reset	
	PT RESET		Select Yes/No to carry out P/T reset	
	COLOR SYSTEM		COLOR/CMYK reset	
	ZOOM FOCUS RESET		Zoom/Focus reset	
	FRAMING SYS		Framing reset	
	OTHER		Zoom/ Focus/ Prism/ Framing reset	
INFO	FIXTURE HOURS		Hours of fixture use	
	LED USE HOURS		LED use time	
	TEMPERATURE		LED temperature	
	VERSION		Software versions	
	NETWORK		Check network parameter	
	RDM	UID	0x388Axxxxxxx	Check fixture's ID
		LABEL		Check fixture's LABEL
	SYSTEM ERROR	MEMORY IC		Memory IC
		ANGLESENSOR		Angle Sensor
		PAN SENSOR		Pan Sensor
		PAN ENCODER		Pan Encoder
		PAN DRIVEIC		Pan Drive IC
		TILT SENSOR		Tilt Sensor
		TILT ENCODER		Tilt Encoder
		TILT DRIVEIC		Tilt Drive IC
		TEMPERATURE		Temperature
		CMY_C RESET		CMY C Reset
		CMY_M RESET		CMY M Reset
		CMY_Y RESET		CMY Y Reset
		CTO		CTO Reset
COLOR RESET		Color Reset		
FGOBO RESET		Fixed Gobo Reset		
GOBO RESET		Gobo Reset		
RGOBO RESET		Rotate Gobo Reset		
ANIMATION RESET		Animation Reset		
ZOOM RESET		Zoom Reset		

		FOCUS RESET		Focus Reset
		PRISM RESET		Prism Reset
		FROST RESET		Frost Reset
		FRAMING		Framing Reset
SERVICE	****	PAN	±127	Pan position fine adjustment
		TILT	±127	Tilt position fine adjustment
		COLOR	±127	Color position fine adjustment
		CMY-C	±127	CMY-C position fine adjustment
		CMY-M	±127	CMY-M position fine adjustment
		CMY-Y	±127	CMY-Y position fine adjustment
		CTO	±127	CTO position fine adjustment
		FIXED GOBO	±127	Fixed Gobo position fine adjustment
		ROTA. GOBO	±127	Rotate Gobo position fine adjustment
		GOBO.ROTA	±127	Self-rotation position fine adjustment
		ANIMATION	±127	Animation position fine adjustment
		FOCUS	±127	Focus position fine adjustment
		ZOOM	±127	Zoom position fine adjustment
		IRIS	±127	Iris position fine adjustment
		PRISM1	±127	Prism 1 position fine adjustment
		FRAMING1	±127	Framing position fine adjustment
		FRAMING2	±127	Framing position fine adjustment
		FRAMING3	±127	Framing position fine adjustment
		FRAMING4	±127	Framing position fine adjustment
		FRAMING ROT	±127	Framing position fine adjustment
		OTHER	±127	
UPDATE SOFTWARE				USB-C Update software
All passwords of this product are <UP>, <DOWN>,<UP>, <DOWN>, <ENTER>				

4 USING A DMX512 CONTROLLER

4.1 DMX CONTROL

BASIC (35CH)	STANDARD (41CH)	Extend (44CH)	Value	Function
CH.1	CH.1	CH.1	000-255	PAN 0-540°
-	CH.2	CH.2	000-255	PAN FINE
CH.2	CH.3	CH.3	000-255	TILT 0-270°
-	CH.4	CH.4	000-255	TILT FINE
CH.3	CH.5	CH.5	000-255	PT Speed
CH.4	CH.6	CH.6	000-255	CYAN
CH.5	CH.7	CH.7	000-255	MAGENTA
CH.6	CH.8	CH.8	000-255	YELLOW
CH.7	CH.9	CH.9	000-255	CTO 6800K-3000K
CH.8	CH.10	CH.10	COLOUR MACRO	
			000-019	No Function
			020-021	3000K
			022-023	3200K
			024-025	3500K
			026-027	4000K
			028-029	4500K
			030-031	5000K
			032-033	5400K
			034-035	5600K
			036-037	6000K
			038-039	6500K
			040-041	6800K
			042-043	L106
			044-045	L194
			046-047	L019
			048-049	R08
			050-051	L213
			052-053	R80
			054-055	L202
056-057	L328			
058-059	R3314			
060-061	L101			
062-063	L768			
064-255	MACRO EFFECT R->G->B->R			
CH.9	CH.11	CH.11	000-255	CMYK SPEED(SPEED 100%->1)

CH.10	CH.12	CH.12	COLOR WHELL	
			000-007	WHITE
			008-015	COLOR 1
			016-023	COLOR 2
			024-031	COLOR 3
			032-039	COLOR 4
			040-047	COLOR 5
			048-055	COLOR 6
			056-191	COLOR WHELL 0-360°
			192-222	COLOR WHELL RAINBOW EFFECT(SPEED 100%→1)
			223-224	STOP
225-255	COLOR WHELL RAINBOW EFFECT(SPEED 1→100%)			
-	-	CH.13	000-255	COLOR WHELL FINE
CH.11	CH.13	CH.14	ROTATING GOBO	
			000-010	ROTATING WHITE
			011-018	ROTATING GOBO 1
			019-026	ROTATING GOBO 2
			027-034	ROTATING GOBO 3
			035-042	ROTATING GOBO 4
			043-050	ROTATING GOBO 5
			051-058	ROTATING GOBO 6
			059-066	ROTATING GOBO 7
			067-074	ROTATING GOBO 1 SHAKE (SPEED 1 → 100%)
			075-082	ROTATING GOBO 2 SHAKE (SPEED 1 → 100%)
			083-090	ROTATING GOBO 3 SHAKE (SPEED 1 → 100%)
			091-098	ROTATING GOBO 4 SHAKE (SPEED 1 → 100%)
			099-106	ROTATING GOBO 5 SHAKE (SPEED 1 → 100%)
			107-114	ROTATING GOBO 6 SHAKE (SPEED 1 → 100%)
			115-122	ROTATING GOBO 7 SHAKE (SPEED 1 → 100%)
			123-127	WHITE
			128-190	STATIC GOBO POSITIVE WATER EFFECT (SPEED 100 → 1%)
			191-192	STOP WATER EFFECT
193-255	STATIC GOBO REVERSE WATER EFFECT (SPEED 1 → 100%)			
CH.12	CH.14	CH.15	GOBO ROTATING	
			0-120	ROTATING GOBO ANGLE ADJUSTMENT (0 → 360°)
			121-125	STOP
			126-165	ROTATING GOBO SHAKE (SPEED 1 → 100%)
			166-170	STOP
			171-210	ROTATING GOBO POSITIVE ROTATION (SPEED 100% → 1)
211-215	STOP			

			216-255	ROTATING GOBO REVERSE ROTATION (SPEED 1 → 100%)
-	CH.15	CH.16	000-255	GOBO ROTATING FINE
CH.13	CH.16	CH.17	FIXED GOBO WHEEL	
			0-10	WHITE
			11-15	FIXED GOBO WHEEL 1
			16-20	FIXED GOBO WHEEL 2
			21-25	FIXED GOBO WHEEL 3
			26-30	FIXED GOBO WHEEL 4
			31-35	FIXED GOBO WHEEL 5
			36-40	FIXED GOBO WHEEL 6
			41-45	FIXED GOBO WHEEL 7
			46-50	FIXED GOBO WHEEL 8
			51-55	FIXED GOBO WHEEL 9
			56-60	FIXED GOBO WHEEL 10
			61-65	FIXED GOBO WHEEL 1 SHAKE (SPEED 1 → 100%)
			66-70	FIXED GOBO WHEEL 2 SHAKE (SPEED 1 → 100%)
			71-75	FIXED GOBO WHEEL 3 SHAKE (SPEED 1 → 100%)
			76-80	FIXED GOBO WHEEL 4 SHAKE (SPEED 1 → 100%)
			81-85	FIXED GOBO WHEEL 5 SHAKE (SPEED 1 → 100%)
			86-90	FIXED GOBO WHEEL 6 SHAKE (SPEED 1 → 100%)
			91-95	FIXED GOBO WHEEL 7 SHAKE (SPEED 1 → 100%)
			96-100	FIXED GOBO WHEEL 8 SHAKE (SPEED 1 → 100%)
			101-105	FIXED GOBO WHEEL 9 SHAKE (SPEED 1 → 100%)
106-110	FIXED GOBO WHEEL 10 SHAKE (SPEED 1 → 100%)			
			111-127	WHITE
			128-190	STATIC GOBO JUMPING WATER EFFECT (SPEED 100 → 1%)
			191-192	STOP WATER EFFECT
			193-255	STATIC GOBO FLOWING WATER EFFECT (SPEED 1 → 100%)
CH.14	CH.17	CH.18	0-255	Insert effect wheel
CH.15	CH.18	CH.19	ANIMATION DISC ROTATION	
			0-10	Rotation STOP
			11-127	Animation Insertion CW Rotate Slow to Fast
			128-138	Rotation STOP
			139-255	Animation Insertion CCW Rotate Fast to Slow
CH.16	CH.19	CH.20	PRISM	
			0-10	WHITE
			11-145	PRISM INSERT AND ADJUST THE ANGLE (0 → 360°)
			146-150	STOP
			151-200	PRISM INSERT AND POSITIVE ROTATION (SPEED 100% → 1)
			201-205	STOP

			206-255	PRISM INSERT AND REVERSE ROTATION (SPEED 1 → 100%)
CH.17	CH.20	CH.21	FROST 1	
			0-255	FROST (0-100%)
CH.18	CH.21	CH.22	FROST 2	
			0-255	FROST (0-100%)
CH.19	CH.22	CH.23	IRIS	
			0-127	IRIS OPEN → CLOSE (FROM LARGE TO SMALL)
			128-130	IRIS CLOSE
			131-171	IRIS FAST IN FAST OUT
			172-211	IRIS FADE IN FADE OUT RANDOMLY
			212-251	IRIS FAST IN FADE OUT RANDOMLY
			252-255	IRIS CLOSE
-	-	CH.24	000-255	IRIS FINE
CH.20	CH.23	CH.25	0-255	ZOOM
-	CH.24	CH.26	0-255	ZOOM FINE
CH.21	CH.25	CH.27	0-255	FOCUS
-	CH.26	CH.28	0-255	FOCUS FINE
CH.22	CH.27	CH.29	AUTO FOCUS	
			0-12	NO FUNCTION
			13-39	5 METER
			40-66	7 METER
			67-93	9 METER
			94-120	11 METER
			121-147	13 METER
			148-174	15 METER
			175-201	17 METER
			202-228	19 METER
229-255	21 METER			
CH.23	CH.28	CH.30	0-255	AUTO FOCUS FINE
CH.24	CH.29	CH.31	0-255	FRAMING1.Left
CH.25	CH.30	CH.32	0-255	FRAMING1.Right
CH.26	CH.31	CH.33	0-255	FRAMING2.Left
CH.27	CH.32	CH.34	0-255	FRAMING2.Right
CH.28	CH.33	CH.35	0-255	FRAMING3.Left
CH.29	CH.34	CH.36	0-255	FRAMING3.Right
CH.30	CH.35	CH.37	0-255	FRAMING4.Left
CH.31	CH.36	CH.38	0-255	FRAMING4.Right
CH.32	CH.37	CH.39	ALL FRAMING ROTATION	
			0-255	FRAMING ROT
-	-	CH.40	0-255	FRAMING ROTATION FINE

CH.33	CH.38	CH.41	0-255	DIMMER
-	CH.39	CH.42	0-255	DIMMER FINE
CH.34	CH.40	CH.43	STROBE	
			0-9	NO FUNCTION
			10-99	STROBE (FROM SLOW TO FAST)
			100-109	NO FUNCTION
			110-179	LIGHTNING STROBE
			180-189	NO FUNCTION
			190-255	RANDOM SROBE
CH.35	CH.41	CH.44	CONTROL(EXECUTE AFTER 3 SECONDS)	
			000-010	NO FUNCTION
			011-020	PAN/TILT BLACK ACTIVATED
			021-030	PAN/TILT BLACK DEACTIVATED
			031-040	PAN INVERT
			041-050	TILT INVERT
			051-060	PAN/TILT INVERT OFF
			061-070	STUDIO
			071-080	POWER
			081-100	LIVE
			101-110	DIM4
			111-120	DIM3
			121-130	DIM2
			131-140	DIM1
			141-150	DIM0
			151-160	1200Hz
			161-170	2400Hz
			171-180	4000Hz
			181-190	6000Hz
			191-200	25000Hz
			201-210	ALL RESET
			211-220	XY RESET
			221-230	COLOR\GOBO SYSTEM RESET
			231-240	FOCUS\ZOOM RESET
241-250	FRAMING RESET			
251-255	NO FUNCTION			