

User Manual

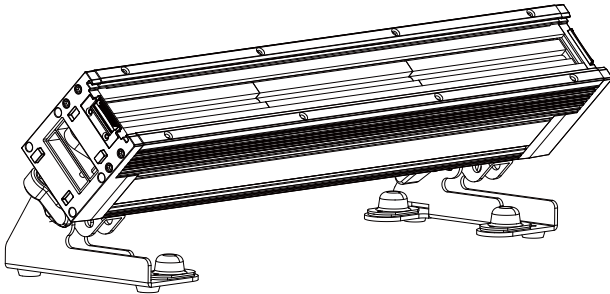

Please read carefully before use

Please Note: Specifications and improvements in the design of this unit and this manual are subject to change without any prior written notice.

SAFETY INTRODUCTION

Before you operate this unit read the manual carefully. Always make sure to include the manual if you pass/rent/sell the unit to another user. Keep in mind that this manual cannot address all possible dangers and environments. Please use your own caution when operating. This product is for professional use only. It is not for household use.



- Do not operate the unit in areas of high temperature conditions. It will cause abnormal function or damage the product.
- Always use a suitable safety wire when mounting the light overhead.
- Connect the safety wire only to the intended safety mount.
- Always follow local safety requirements.



- Only qualified personnel may repair this product.
- Do not open the product housing.
- Do not apply power if the light is damaged.



- Do not directly look into the light.
- It can cause harm to your eyes.
- Do not look at the LEDs with a magnifying glass or any other optical instrument that may concentrate the light output.
- Please don't look at the light directly when the light's radiation temperature reach 40 °C



- The exterior surfaces of the light can become hot, up to 55°C during normal operation.
- Ensure that accidental physical contact with the device is impossible.
- Install only in ventilated locations.
- Do not cover the light.



- Always charge with the flight case open.
- It is recommended to charge at a temperature between 15°C and 35°C



- Do not look directly at the light source.



- Don't throw the unit into the garbage at the end of its lifetime.
- Make sure to dispose is according to your local ordinances and/or regulations, to avoid polluting the environment!
- The packaging is recyclable and can be disposed.



—2.0m ta 45 °C

GENERAL PRODUCT INFORMATION

1. Standard Configuration

- 1x VEKTOR S
- 1x True one power cable

In addition, we offer a range of professional accessories (optional). Please see under menu or at our website www.leding.pt

2. Control Functions

- 3/4/8/12/16/17/17D/32/41CH
- Master&Slave mode
- CRMX Wireless DMX(optional)
- VISION APP(optional)

3. Features

- Light Source: Main Led Panel:32*8W RGBL
- Native beam angle(s):60x20°
- Initial field of view (spot angle):85x25°
- Type of optical system:AP04-long strip lens
- Color Temperature (at full):12000k
- Power consumption: 80W
- Input voltage,nominal:100 - 240V 50/60Hz
- Efficacy:60.57lm/w
- Light output all LEDs on: 4718 LM
- Illuminance Lux @ 2m:1550 lx
- Illuminance Lux @ 5m:248 lx
- Illuminance Lux @ 8m:97 lx
- Illuminance Lux @ 10m:62 lx
- Run Mode: DMX 512 /Master Slave/Auto Run
- Maximum 66 ID setting for easy separately control
- Wireless DMX from Sweden
- 10 internal programs and 10 customerize programs
- 4 different dimming curve
- Strobe:0 - 20Hz adjustable
- Tilt:0-90°
- Pixel control: 8 Sections
- IP65
- Temperature: -40°C~45°C
- N.W: 3.48 KG
- Dimensions: 516 x 140 x 170mm

INSTALLATION&SETUP

1. Connections

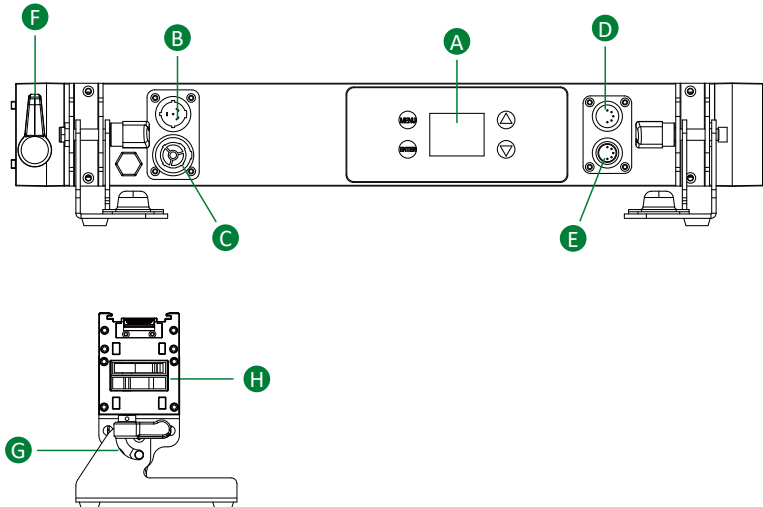

A: LCD Screen

B: Power In

C: DMX In

D: DMX Out

E: Power Out

F: Knob

G: Stand 0-90°

H: Double locking system

OPERATION

1. Control Display

 LCD Touch Screen

  Press arrows to scroll up and down inside the menu and change values, such as DMX address

 Press ENTER to access theselection menu for system settings or confirm changes

2. Displayer Introduction

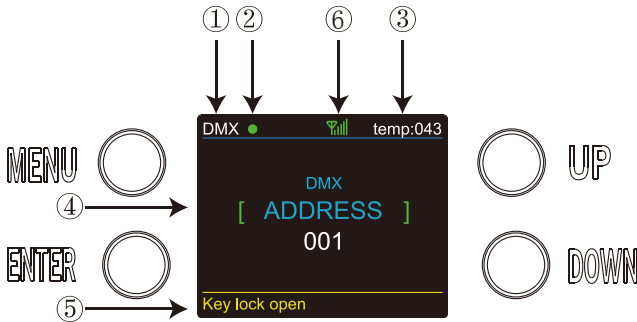

1. When you enter DMX Mode, it will be showed DMX, when you enter SLAVE Mode, it will be showed SLAVE.
2. This shows the condition of signal transmission. Green is connected. Red is disconnected.
3. This shows the temperature of the lights.
4. This shows the menus you can select.
5. This shows the condition of key lock. "Key lock open" means it is open and "Key lock off" means it is close.
6. This shows the condition of wireless signal. Green is connected. Red is disconnected.

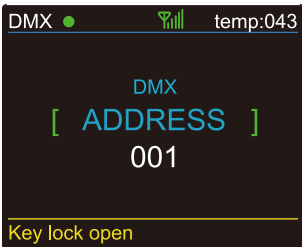

While DMX and Wireless signal are green, it means DMX Mode and Wireless are connected.

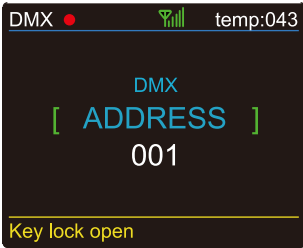

While DMX shows red but Wireless signal shows green, it means DMX Mode is disconnected and Wireless is connected.

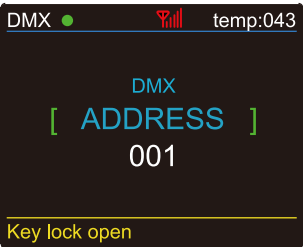

While DMX shows green but Wireless signal shows red, it means DMX Mode is connected and Wireless is disconnected.

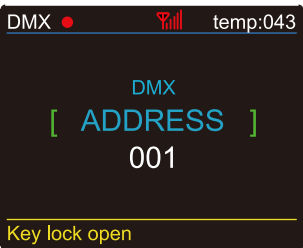

While DMX and Wireless are shown red, it means DMX Mode and Wireless are disconnected.

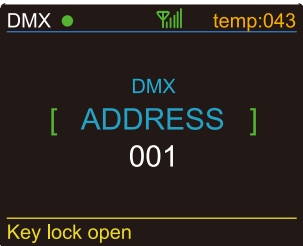

While the letters and number show change from white to yellow, it means the temperature is beyond the maximum temperature of default settings.

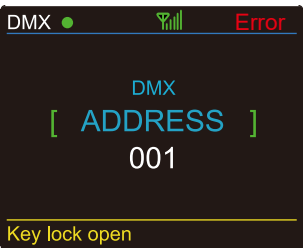

While the letters and number show Error, it means there are some temperature problems.

3. DMX connection

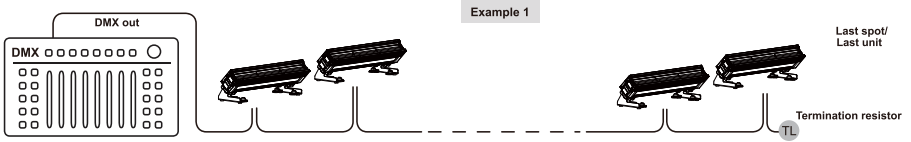

4. Master / Slave connection

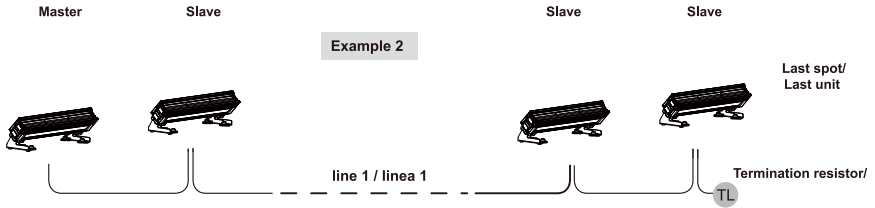

5. CABLE CONNECTORS

Cabling must have a male XLR connector on one's end and a female XLR connector on the other's end.

DMX connector configuration

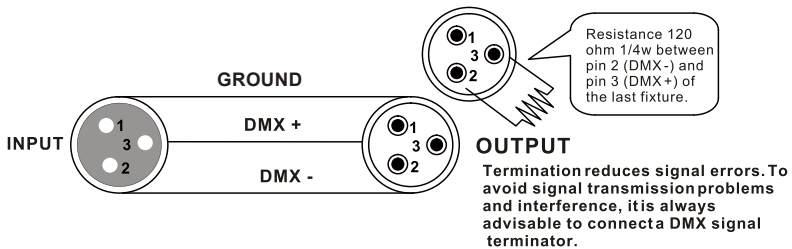

Caution: Do not allow contact between the ground and the fixture's chassis ground. Grounding the ground can cause a ground loop, and your fixture may perform erratically. Test cables with an ohm meter to verify positive pole and to make sure the pins are not grounded or shorted to the shield or each other.

3-PIN TO 5-PIN CONVERSION CHART

Please note if you use a controller with a 5 pin DMX output connector, you need to use a 5 pin to 3 pin adapter. The chart below details a proper cable conversion:

3-PIN TO 5-PIN CONVERSION CHART

Conductor	3 Pin Female (output)	5 Pin Male (Input)
Ground/Shield	Pin 1	Pin 1
Data (-) signal	Pin 2	Pin 2
Data (+) signal	Pin 3	Pin 3
Do not use		Do not use
Do not use		Do not use

PROGRAMME MENU

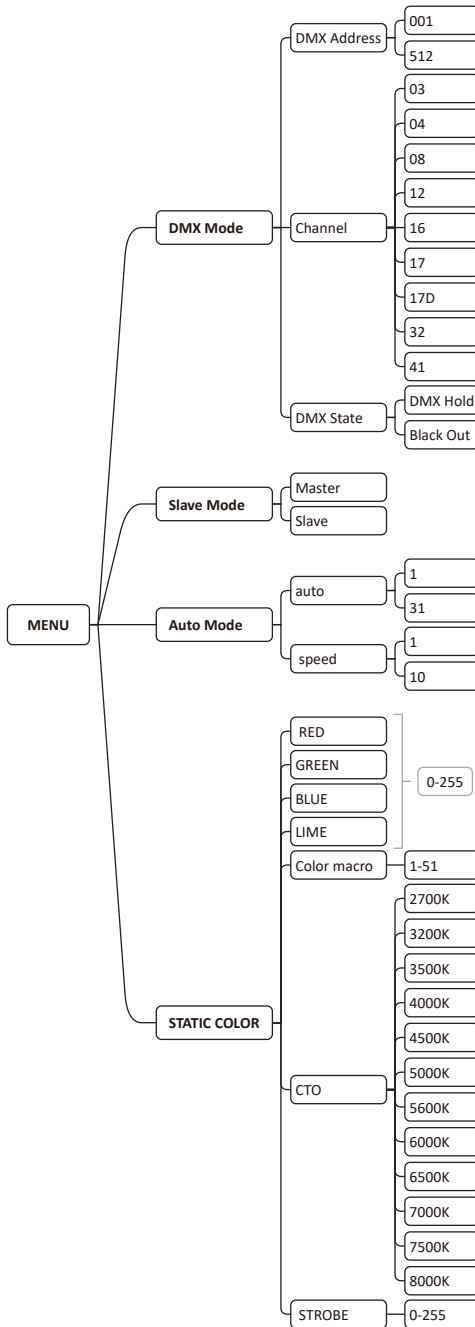

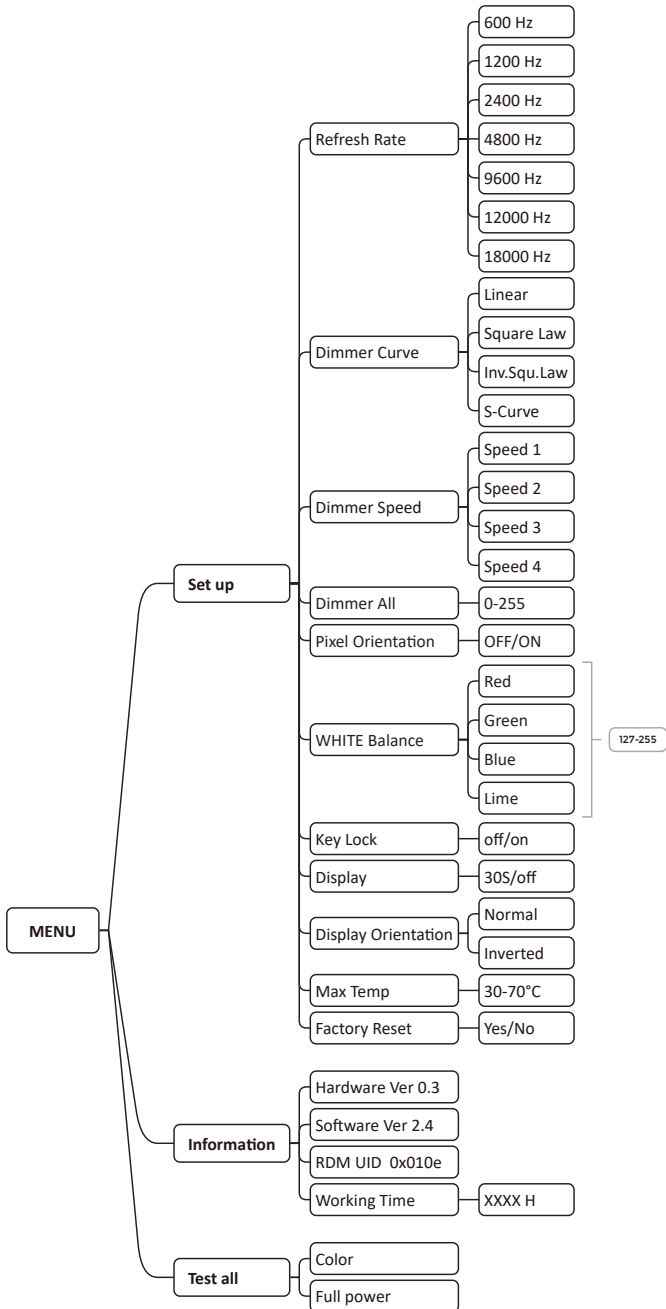

DMX Address and Channels Mode-In these menu,you can connect several pieces of lights with DMX cable and control them with control console.

1. Press "ENTER" and then press "UP" or "DOWN" to "DMX Address" or "Channels Mode" and press "ENTER".

1) "XXX" will be showed in "DMX Address", "XXX" means the Address 1-512. You can press "UP" or "DOWN" to select the address you desired.

2) "Channel [xx]" will be showed in "Channels Mode", "XX" means 9 kinds of DMX Channels Modes. You can press "UP" or "DOWN" to select the Channel Mode you desired.

3) DMX STATE-In this menu,you can choose the DMX signal you desired. Press "ENTER" and you can choose "BLACKOUT" or "DMX HOLD";"BLACKOUT" means cut off the DMX signal and "DMX HOLD" means connect DMX signal.

SLAVE MODE-In this menu, you can select one light as the MASTER light and other lights in SLAVE Mode will run following the MASTER light.

1. Press "ENTER" and then press "UP" or "DOWN" to "SLAVE Mode".

2.Press "ENTER" and "SLAVE" will be showed, then press "ENTER" to select.

AUTO MODE-In this menu, you can select your desire AUTO Mode and adjust the running speed.

1. Press "ENTER" and then press "UP" or "DOWN" to "AUTO MODE".

2. Press "ENTER" then "SPEED" or "AUTO MODE" is showed.Then press "ENTER" and you can see 2 items as below:

1) SPEED - It provides "01-10" for you choose.

2) AUTO MODE - It provides "AUTO 1- AUTO 30" for you choose.

Manual MODE-In this menu,you can adjust dimmer, halogen, strobe you desired.

1. Press "ENTER" and then press "UP" or "DOWN" to "MANUAL MODE".

2. Press "ENTER" and there has 8 options then press "UP" or "DOWN" to select the value you desired as below:

1) Dimmer - You can adjust the overall brightness in this menu.

2) Red - You can adjust the brightness of Red in this menu.

3) Green - You can adjust the brightness of Green in this menu.

4) Blue - You can adjust the brightness of Blue in this menu.

5) Lime - You can adjust the brightness of Lime in this menu.

6) Color Macro - You can select color 0-51 in this menu.

7) CTO - You can adjust the color temperature in this menu.

8) STROBE - You can adjust the speed of strobe in this menu.

SET UP-In this menu, you can adjust the value of the function.

1. Press "ENTER" and then press "UP" or "DOWN" to "SET UP".

2. Press "ENTER" and there has 13 options then press "ENTER" to select the options and press "UP" or "DOWN" to select the value you desired as below:

1)RedShift - In this item,the lamp displays the halogen effect when you select ON,and the lamp turns off the halogen effect when you select OFF.

2)Refresh Rate - it provides 1-18KHz of refresh rates for your choose

3)Dimmer Curve - It provides 4 kinds of dimmer curves for you choose.

4)Dimmer response - It provides 4 kinds of dimmer speed for you choose.

5)Pixel Orientation - You can select "OFF" or "ON" set the forward and reverse direction of the auxiliary light and white light scrolling.

6)User CAL - You can adjust the brightness of Red, Green, Blue, Lime.

7)Key Lock - You can select "OFF" or "ON" to make the Key Lock turn off all the time or turns on.

8)Display - You can select "OFF" or "30s".

- 9) Display Orientation - You can select "Normal" or "Invertde".
- 10) Bat Time - You can select different battery usage times for "4H/6H/8H/12H"
- 11) Max Temp - The max temperature range for use is 40-70°C
- 12) Redshift - You can select "on" or "off" to enable the Redshift.
- 13) FACTORY RESET-In this item, you can reset all the value of the system.

Wireless-In this menu,you can receiver and release wireless signals.

- 1.Press"ENTER"button and then UP or DOWN button until "Wireless" is showed.
- 2.Press"ENTER""button,and "Receiver" or "Release" will be showed. Then press ENTER,and you can see two items as below:
 - 1)Receiver- In this item,you can select "ON"or "OFF".If you select ON,you can use the wireless reception function.And if you select OFF,wireless reception will be turned off.
 - 2)Release-In this item, you can clear wireless signals."SUCCEESS" will be displayed when the wireless signal is successfully cleared.

INFORMATION-In this menu, you can learn about the information of RDM, software, hardware , serial number, temperatures and the run time of the light.

1. Press "ENTER" and then press "UP" or "DOWN" to "INFORMATION".
2. Press "ENTER" and select "RDM" , "Serial number" , "Software" , "Hardware" or "Working Time".Then press "ENTER",you can see 5 items as below:
 - 1) Serial number - It shows the serial number information.
 - 2) Hardware - It shows the Hardware information.
 - 3) Software - It shows the Software information.
 - 4) RDMUID - It shows RDM information.
 - 5) Working Time - It shows the working hours of the light.

Test mode - In this menu,you can test if the light work normally.

1. Press "ENTER" and then press "UP" or "DOWN" to "Test mode".
- 2.Press"ENTER""button,and "Color" or "Full power" will be showed. Then press ENTER,and you can see two items as below:
 - 1) Color - Test RGB LED twice.
 - 2) Full power - Test RGB and white light full brightness for 5s.

DMX CONTROL MODE

3 CHANNELS		
Channel	Value	Function
1	000 - 255	Master dimmer
2	000 - 255	Color marco (1-51)
3	000 - 255	11 White (2500K-10000K)

4 CHANNELS		
Channel	Value	Function
1	000 - 255	Red
2	000 - 255	Green
3	000 - 255	Blue
4	000 - 255	Lime

8 CHANNELS		
Channel	Value	Function
1	000 - 255	Red
2	000 - 255	Red fine
3	000 - 255	Green
4	000 - 255	Green fine
5	000 - 255	Blue
6	000 - 255	Blue fine
7	000 - 255	Lime
8	000 - 255	Lime fine

12 CHANNEL		
Channel	Value	Function
1	000 - 255	Master dimmer
2	000 - 255	Fine dimmer
3	000 - 255	Shutter
4	000 - 255	Red
5	000 - 255	Green
6	000 - 255	Blue
7	000 - 255	Lime
8	000 - 255	Dimmer curve
9	000 - 255	Dimmer speed
10	000 - 255	Auto
11	000 - 255	Auto speed
12	000 - 255	Fade

16 CHANNELS		
Channel	Value	Function
1	000 - 255	LED 1-2 Red
2	000 - 255	LED 1-2 Green
3	000 - 255	LED 1-2 Blue
4	000 - 255	LED 1-2 Lime
5	000 - 255	LED 3-4 Red
6	000 - 255	LED 3-4 Green
7	000 - 255	LED 3-4 Blue
8	000 - 255	LED 3-4 Lime
9	000 - 255	LED 5-6 Red
10	000 - 255	LED 5-6 Green
11	000 - 255	LED 5-6 Blue
12	000 - 255	LED 5-6 Lime
13	000 - 255	LED 7-8 Red
14	000 - 255	LED 7-8 Green
15	000 - 255	LED 7-8 Blue
16	000 - 255	LED 7-8 Lime

17 CHANNELS		
Channel	Value	Function
1	000 - 255	Master Dimmer
2	000 - 255	Fine dimmer
3	000 - 255	Function set
4	000 - 255	Shutter
5	000 - 255	Red
6	000 - 255	Red fine
7	000 - 255	Green
8	000 - 255	Green fine
9	000 - 255	Blue
10	000 - 255	Blue fine
11	000 - 255	Lime
12	000 - 255	Lime fine
13	000 - 215	Color marco 0-51
	216 - 255	Lime (2500K-10000K)
14	000 - 255	Dimmer speed
15	000 - 255	Auto
16	000 - 255	Auto speed
17	000 - 255	Fade

17D CHANNELS		
Channel	Value	Function
1	000 - 255	Master Dimmer
2	000 - 255	Function set
3	000 - 255	Shutter
4	000 - 255	Red
5	000 - 255	Green
6	000 - 255	Blue
7	000 - 255	Lime
8	000 - 255	Color marco 0-51
	000 - 255	Lime (2500K-10000K)
9	000 - 255	Dimmer speed
10	000 - 255	LED 1 dimmer
11	000 - 255	LED 2 dimmer
12	000 - 255	LED 3 dimmer
13	000 - 255	LED 4 dimmer
14	000 - 255	LED 5 dimmer
15	000 - 255	LED 6 dimmer
16	000 - 255	LED 7 dimmer
17	000 - 255	LED 8 dimmer

32 CHANNELS		
Channel	Value	Function
1	000 - 255	LED 1 Red
2	000 - 255	LED 1 Green
3	000 - 255	LED 1 Blue
4	000 - 255	LED 1 Lime
5	000 - 255	LED 2 Red
6	000 - 255	LED 2 Green
7	000 - 255	LED 2 Blue
8	000 - 255	LED 2 Lime
9	000 - 255	LED 3 Red
10	000 - 255	LED 3 Green
11	000 - 255	LED 3 Blue
12	000 - 255	LED 3 Lime
13	000 - 255	LED 4 Red
14	000 - 255	LED 4 Green
15	000 - 255	LED 4 Blue
16	000 - 255	LED 4 Lime
17	000 - 255	LED 5 Red
18	000 - 255	LED 5 Green
19	000 - 255	LED 5 Blue
20	000 - 255	LED 5 Lime
21	000 - 255	LED 6 Red
22	000 - 255	LED 6 Green
23	000 - 255	LED 6 Blue
24	000 - 255	LED 6 Lime
25	000 - 255	LED 7 Red
26	000 - 255	LED 7 Green
27	000 - 255	LED 7 Blue
28	000 - 255	LED 7 Lime
29	000 - 255	LED 8 Red
30	000 - 255	LED 8 Green
31	000 - 255	LED 8 Blue
32	000 - 255	LED 8 Lime

41 CHANNELS		
Channel	Value	Function
1	000 - 255	Master Dimmer
2	000 - 255	Fine dimmer
3	000 - 255	Function set
4	000 - 255	Shutter
5	000 - 255	LED 1 Red
6	000 - 255	LED 1 Green
7	000 - 255	LED 1 Blue
8	000 - 255	LED 1 Lime
9	000 - 255	LED 2 Red
10	000 - 255	LED 2 Green
11	000 - 255	LED 2 Blue
12	000 - 255	LED 2 Lime
13	000 - 255	LED 3 Red
14	000 - 255	LED 3 Green
15	000 - 255	LED 3 Blue
16	000 - 255	LED 3 Lime
17	000 - 255	LED 4 Red
18	000 - 255	LED 4 Green
19	000 - 255	LED 4 Blue
20	000 - 255	LED 4 Lime
21	000 - 255	LED 5 Red
22	000 - 255	LED 5 Green
23	000 - 255	LED 5 Blue
24	000 - 255	LED 5 Lime
25	000 - 255	LED 6 Red
26	000 - 255	LED 6 Green
27	000 - 255	LED 6 Blue
28	000 - 255	LED 6 Lime
29	000 - 255	LED 7 Red
30	000 - 255	LED 7 Green
31	000 - 255	LED 7 Blue
32	000 - 255	LED 7 Lime
33	000 - 255	LED 8 Red
34	000 - 255	LED 8 Green

35	000 - 255	LED 8 Blue
36	000 - 255	LED 8 Lime
37	000 - 255	Dimmer speed
38	000 - 255	Color marco
	000 - 255	Lime (2500K-10000K)
39	000 - 255	Auto
40	000 - 255	Auto speed
41	000 - 255	Fade

DMX CONTROL SHEET

Function set	
000 - 044	No function
045 - 049	Pixel on
050 - 054	Pixel off
055 - 059	Dimmer curve Linear
060 - 064	Dimmer curve Square Law
065 - 069	Dimmer curve inverse Square Law
070 - 074	Dimmer curve S-Curve
075 - 089	No function
090 - 094	Calibrated color output mode - COLOR CALIB = On
095 - 099	Raw color ouput mode - COLOR CALIB = OFF
100 - 114	No function
115 - 119	1KHzrefresh rate
120 - 124	2KHzrefresh rate
125 - 129	3KHzrefresh rate
130 - 134	4KHzrefresh rate
135 - 139	5KHzrefresh rate
140 - 144	6KHzrefresh rate
145 - 149	7KHzrefresh rate

150 - 154	8KHzrefresh rate
155 - 159	9KHzrefresh rate
160 - 164	10KHzrefresh rate
165 - 169	11KHzrefresh rate
170 - 174	12KHzrefresh rate
175 - 179	13KHzrefresh rate
180 - 184	14KHzrefresh rate
185 - 189	15KHzrefresh rate
190 - 194	16KHzrefresh rate
195 - 199	17KHzrefresh rate
200 - 204	18KHzrefresh rate
205 - 249	No function
250 - 255	Illuminate display

CTO		
8	29	2700K
30	51	3200K
52	73	3500K
74	95	4000K
96	117	4500K
118	139	5000K
140	161	5600K
162	183	6000K
184	205	6500K
206	227	7000K
228	249	7500K
250	255	8000K

Dimmer speed		
0	49	No function
50	99	Dimmer speed 1
100	149	Dimmer speed 2
150	199	Dimmer speed 3
200	255	Dimmer speed 4

Shutter sheet	
000 - 019	Shutter close
020 - 024	Shutter open
025 - 064	Strobe 1 (fast to slow)
065 - 069	Shutter open
070 - 084	Strobe 2:opening pulse (fast to slow)
085 - 089	Shutter open
090 - 104	Strobe 3:closing pulse (fast to slow)
105 - 109	Shutter open
110 - 124	Strobe 4:random strobe (fast to slow)
125 - 129	Shutter open
130 - 144	Strobe 5:random opening pulse (fast to slow)
145 - 149	Shutter open
150 - 164	Strobe 6:random closing pulse (fast to slow)
165 - 169	Shutter open
170 - 184	Strobe 7:burst pulse (fast to slow)
185 - 189	Shutter open
190 - 204	Strobe 8:random burst pulse (fast to slow)
205 - 209	Shutter open
210 - 224	Strobe 9: sine wave(fast to slow)
225 - 229	Shutter open
230 - 244	Strobe 10: burst(fast to slow)
245 - 255	Shutter open

Color marco 1-51					
5	9	COLOR 1	130	134	COLOR 26
10	14	COLOR 2	135	139	COLOR 27
15	19	COLOR 3	140	144	COLOR 28
20	24	COLOR 4	145	149	COLOR 29
25	29	COLOR 5	150	154	COLOR 30
30	34	COLOR 6	155	159	COLOR 31
35	39	COLOR 7	160	164	COLOR 32
40	44	COLOR 8	165	169	COLOR 33
45	49	COLOR 9	170	174	COLOR 34
50	54	COLOR 10	175	179	COLOR 35
55	59	COLOR 11	180	184	COLOR 36
60	64	COLOR 12	185	189	COLOR 37
65	69	COLOR 13	190	194	COLOR 38
70	74	COLOR 14	195	199	COLOR 39
75	79	COLOR 15	200	204	COLOR 40
80	84	COLOR 16	205	209	COLOR 41
85	89	COLOR 17	210	214	COLOR 42
90	94	COLOR 18	215	219	COLOR 43
95	99	COLOR 19	220	224	COLOR 44
100	104	COLOR 20	225	229	COLOR 45
105	109	COLOR 21	230	234	COLOR 46
110	114	COLOR 22	235	239	COLOR 47
115	119	COLOR 23	240	244	COLOR 48
120	124	COLOR 24	245	249	COLOR 49
125	129	COLOR 25	250	254	COLOR 50
				255	COLOR 51

Auto 1-31					
6	13	Auto 1	126	133	Auto 16
14	21	Auto 2	134	141	Auto 17
22	29	Auto 3	142	149	Auto 18
30	37	Auto 4	150	157	Auto 19
38	45	Auto 5	158	165	Auto 20
46	53	Auto 6	166	173	Auto 21
54	61	Auto 7	174	181	Auto 22
62	69	Auto 8	182	189	Auto 23
70	77	Auto 9	190	197	Auto 24
78	85	Auto 10	198	205	Auto 25
86	93	Auto 11	206	213	Auto 26
94	101	Auto 12	214	221	Auto 27
102	109	Auto 13	222	229	Auto 28
110	117	Auto 14	230	237	Auto 29
118	125	Auto 15	238	245	Auto 30
			246	255	Auto 31

DIMMER CURVE

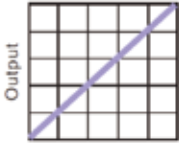

DMX %
LINEAR

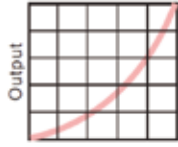

DMX %
SQUARE LAW

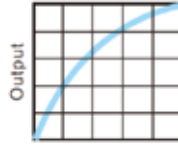

DMX %
INVERSE SQUARE LAW

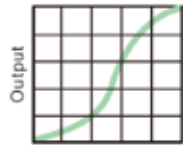

DMX %
S-CURVE

MECHANICAL SPECIFICATION

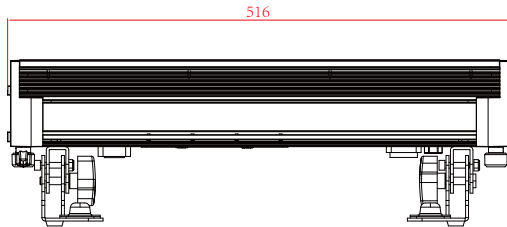
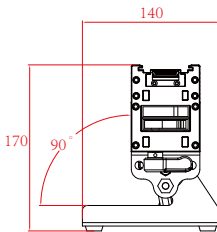

ACCESSORY

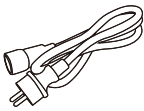

Power cable

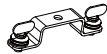

Fast lock

OPTIONAL ACCESSORIES



Frost filter

INSTALLATION

1. Customize your setup with various accessories to achieve diverse lighting effects and installation configurations. Options include:

- Frost filter

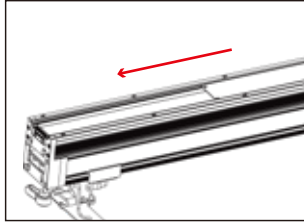
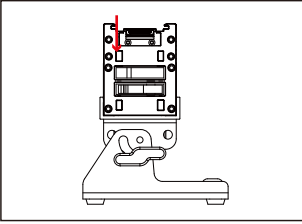

Press the mechanisms on the sides of the end cover. Slide the frost filter into position. Release the mechanisms to lock the frost filter.

SPLICING

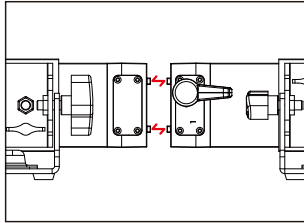
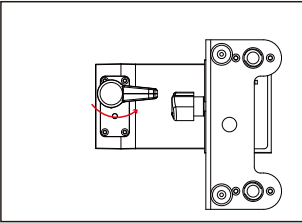

1. Before connecting, rotate the hook fully counterclockwise to the end positions.
2. Use the positioning blocks to align both ends of the fixtures.

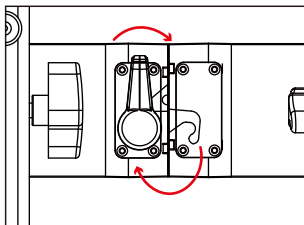
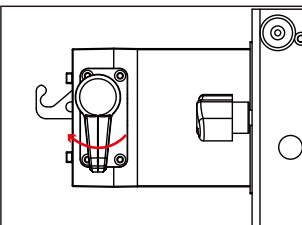

3. Insert the connecting pin into the hole of one end cap. Rotate the C-lock clockwise to secure it.
4. Insert the opposite end of the pin into the hole of the other end cap. Rotate that C-lock clockwise to complete the connection.

RDM

Parameter ID	Command 'Discovery'	Command 'Set'	Command 'Get'
DISC_UNIQUE_BRANCH	√		
DISC_MUTE	√		
DISC_UN_MUTE	√		
DEVICE_INFO			√
SUPPORTED_PARAMETERS			√
SOFTWARE_VERSION_LABEL			√
DMX_START_ADDRESS		√	√
IDENTIFY_DEVICE		√	√
DEVICE_MODEL_DESCRIPTION			√
PARAMETER_DESCRIPTION			√
MANUFACTURER_LABEL			√
DEVICE_LABEL		√	√
FACTORY_DEFAULTS		√	√
BOOT_SOFTWARE_VERSION_ID			√
BOOT_SOFTWARE_VERSION_LABEL			√
DMX_PERSONALITY		√	√
DMX_PERSONALITY_DESCRIPTION			√
SLOT_INFO			√
SLOT_DESCRIPTION			√
SENSOR_DEFINITION			√
SENSOR_VALUE			√
DEVICE_HOURS			√
LAMP_HOURS			√
RESET_DEVICE		√	
CURVE		√	√
DMX STATE		√	√
DIMMER SPEED		√	√
“√”-executable command; “x”-to-be-updated command			

